

## Refrigerator Operation Manual

i.Series® and Horizon Series™ - Pass- Thru

Pharmacy  
i.Series  
iPR225, iPR456

Horizon Series  
HPR225, HPR456

Blood Bank  
i.Series  
iB225, iB456

Horizon Series  
HB225, HB456



## Document History

Revision	Date	CO	Supersession	Revision Description
A	14 NOV 2016	12315	n/a	Initial release (all units with serial number 2035000 and greater).
B	22 JAN 2018	13277	B supersedes A	Updated Mute Active Alarms text to provide more detail Updated Table 2. Application icons Updated hysteresis values in Table 3. Parameter Values
C	6 JUN 2019	14712	C supersedes B	Added Section 5 to include information for the i.Lock Interlock feature.

\* Date submitted for Change Order review. Actual release date may vary.

## Document Updates

The document is furnished for information use only, is subject to change without notice and should not be construed as a commitment by Helmer Scientific. Helmer Scientific assumes no responsibility or liability for any errors or inaccuracies that may appear in the informational content contained in this material. For the purpose of clarity, Helmer Scientific considers only the most recent revision of this document to be valid.

## Notices and Disclaimers

### Confidential / Proprietary Notices

Use of any portion(s) of this document to copy, translate, disassemble or decompile, or create or attempt to create by reverse engineering or otherwise replicate the information from Helmer Scientific products is expressly prohibited.

### Copyright and Trademark

Copyright © 2019 Helmer, Inc. Helmer®, i.Series®, i.C<sup>3</sup>®, Horizon Series™, and Rel.i™ are registered trademarks or trademarks of Helmer, Inc. in the United States of America. All other trademarks and registered trademarks are the property of their respective owners. Helmer, Inc., doing business as (DBA) Helmer Scientific and Helmer.

### Disclaimer

This manual is intended as a guide to provide the operator with necessary instructions on the proper use and maintenance of certain Helmer Scientific products.

Any failure to follow the instructions as described could result in impaired product function, injury to the operator or others, or void applicable product warranties. Helmer Scientific accepts no responsibility for liability resulting from improper use or maintenance of its products.

The screenshots and component images appearing in this guide are provided for illustrative purposes only, and may vary slightly from the actual software screens and/or product components.

# Contents

- 1 About this Manual . . . . . 4**
  - 1.1 Safety Precautions and Symbols . . . . . 4
  - 1.2 General Recommendations . . . . . 5
- 2 Installation . . . . . 6**
  - 2.1 Location. . . . . 6
  - 2.2 Placement and Leveling . . . . . 6
  - 2.3 Temperature Probes . . . . . 6
  - 2.4 Chart Recorder (If Included) . . . . . 8
- 3 i.Series® Operation . . . . . 10**
  - 3.1 Initial Power-Up . . . . . 10
  - 3.2 Operation . . . . . 11
  - 3.3 Change Temperature Setpoint . . . . . 11
  - 3.4 Set Alarm Parameters . . . . . 12
  - 3.5 Active Alarms . . . . . 13
  - 3.6 Mute and Disable Active Alarms . . . . . 13
  - 3.7 Light Operation . . . . . 14
- 4 Min/Max Temperature Monitoring . . . . . 15**
- 5 i.Lock™ Interlock Feature (Optional - Pharmacy models only) . . . . . 16**
- 6 Horizon Series™ Operation . . . . . 17**
  - 6.1 Initial Power Up . . . . . 17
  - 6.2 Display Minimum and Maximum Monitor Temperature Recordings . . . . . 17
  - 6.3 Change Temperature Setpoint . . . . . 18
  - 6.4 Set Parameter Values . . . . . 19
  - 6.5 Set Temperature Units. . . . . 19
  - 6.6 Temperature Calibration Offsets . . . . . 19
  - 6.7 Set Alarm Setpoints (Parameters). . . . . 20
  - 6.8 Active Alarms . . . . . 20
  - 6.9 Mute and Disable Audible Alarms . . . . . 20
  - 6.10 Light Operation . . . . . 20
- 7 Product Specifications . . . . . 21**
  - 7.1 Operating Standards. . . . . 21
- 8 Compliance . . . . . 23**
  - 8.1 Safety Compliance . . . . . 23
  - 8.2 Environmental Compliance . . . . . 23
  - 8.3 EMC Compliance . . . . . 23
- Appendix A. . . . . 24**
  - i.Series Parts. . . . . 24
- Appendix B. . . . . 25**
  - Horizon Series Parts . . . . . 25



# 1 About this Manual

This manual provides information on how to use i.Series® and Horizon Series™ blood bank and pharmacy refrigerators. It is intended for use by end users of the refrigerator and authorized service technicians.

Models are indicated by a distinguishing model number that corresponds to the series, type, number of doors and capacity of the freezer. For example, “iPR225” refers to an i.Series Pharmacy Refrigerator with 2 doors and a capacity of 25 cu ft.

Generic references are used throughout this manual to group models that contain similar features. For example, “225 models” refers to all models of that size (iB225, HB225, iPR225, HPR225). This manual covers all pass-thru refrigerators, which may be identified singly, by their size, or by their respective “Series.”

## 1.1 Safety Precautions and Symbols

### Symbols found in this document

The following symbols are used in this manual to emphasize certain details for the user:



**Task** Indicates procedures which need to be followed.



**Note** Provides useful information regarding a procedure or operating technique when using Helmer Scientific products.

**NOTICE** Advises the user against initiating an action or creating a situation which could result in damage to equipment; person injury is unlikely.

**CAUTION** Advises the user against initiating an action or creating a situation which could result in damage to equipment or impair the quality of the products or cause minor injury.

**WARNING** Advises the user against initiating an action or creating a situation which could result in damage to equipment and serious personal injury to a patient or the user.



Manufacturer



Authorized representative in the European Community

### Symbols found on the units

The following symbols may be found on the refrigerator or refrigerator packaging:



CE Mark (European units only)



Earth / ground terminal



Caution: Risk of damage to equipment or danger to operator



Protective earth / ground terminal



Caution: Hot surface



Compliance with Restriction of Hazardous Substances Directive



Caution: Shock / electrical hazard



Compliance with European Union Directive WEEE 2002/96/EC applicable provisions.



Caution: Unlock all casters

### *Avoiding Injury*

Review safety instructions before installing, using, or maintaining the equipment.

- ◆ Before moving unit, ensure doors are closed and casters are unlocked and free of debris.
- ◆ Before moving unit, disconnect the AC power cord and secure the cord.
- ◆ Do not open multiple, loaded drawers at the same time.
- ◆ Do not move a unit whose load exceeds 900 lbs / 408 kg (single-door units) or 1350 lbs / 612 kg (double-door units).
- ◆ Never physically restrict any moving component.
- ◆ Avoid removing electrical service panels and access panels unless so instructed.
- ◆ Keep hands away from pinch points when closing the door.
- ◆ Avoid sharp edges when working inside the electrical compartment and refrigeration compartment.
- ◆ Ensure biological materials are stored at recommended temperatures determined by standards, literature, or good laboratory practices.
- ◆ Proceed with caution when adding and removing samples from the refrigerator.
- ◆ Use manufacturer supplied power cord only.
- ◆ Using the equipment in a manner not specified by Helmer Scientific may impair the protection provided by the equipment.
- ◆ Decontaminate parts prior to sending for service or repair. Contact Helmer Scientific or your distributor for decontamination instructions and a Return Authorization Number.
- ◆ Ensure biological materials are stored safely, in accordance with all applicable organizational, regulatory, and legal requirements.
- ◆ The refrigerator is not considered to be a storage cabinet for flammable or hazardous materials.

### **CAUTION**

Decontaminate parts prior to sending for service or repair. Contact Helmer or your distributor for decontamination instructions and a Return Authorization Number.

## **1.2 General Recommendations**

### **Intended Use**

Helmer refrigerators are intended for the storage of blood products and other medical and scientific products.

### **General Use**

Allow refrigerator to come to room temperature before powering on.

During initial startup, high temperature alarm may activate while refrigerator reaches operating temperature.

### **Initial Loading**

Allow chamber temperature to stabilize at the setpoint before storing product.

### **Product Loading Guidelines**

When loading your refrigerator, take care to observe the following guidelines:

- ◆ Never load refrigerators beyond capacity.
- ◆ Always store items within shelves, drawers or baskets.
- ◆ Temperature uniformity is maintained by air circulation, which could be impeded if unit is overfilled, particularly at the top or against the doors or walls. Ensure proper clearance is provided below the fan.

### **Note**

Products stacked against walls or doors may obstruct air flow and affect performance of unit.

## 2 Installation

### 2.1 Location

- ◆ Has a grounded outlet meeting the electrical requirements listed on the product specification label.
- ◆ Is clear of direct sunlight, high temperature sources, and heating and air conditioning vents.
- ◆ Minimum 8" (203 mm) above.
- ◆ Meets limits specified for ambient temperature (15°C to 32°C) and relative humidity.
- ◆ Clearance above the clean room side may be 0".
- ◆ Top enclosure cannot be placed more than 11" (280 mm) from the front (clean room side) of the refrigerator.
- ◆ Side enclosures may be flush with both sides of the refrigerator.

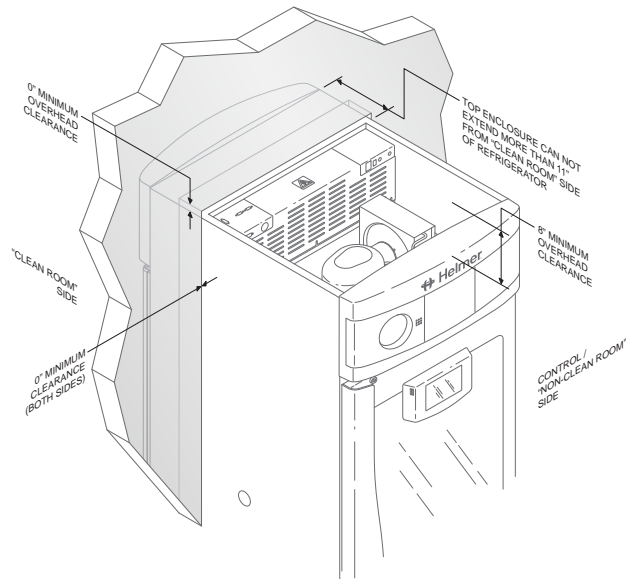

*Clearance requirements for pass-thru refrigerator enclosure.*

### 2.2 Placement and Leveling

#### CAUTIONS

- To prevent tipping, ensure the casters are unlocked, and the doors are closed before moving the refrigerator.

1. Roll refrigerator into place and lock casters.
2. Ensure refrigerator is level.

### 2.3 Temperature Probes

Probe bottle(s) along with a container of glycerin have been provided with this unit. The glycerin is used to create a solution which simulates the product stored in the refrigerator. The product simulation solution temperature reflects the product's temperature during normal operation.

#### Notes

- Temperature probes are fragile; handle with care.
- Number and location of probes varies by model.
- Remote probes may also be introduced through the existing top port.

### Primary Monitor Probe

The primary monitor probe is located in the top right corner of the refrigerator (as accessed from the clean room side).



*Primary monitor probe with optional chart recorder probe*

### Secondary Probe

The secondary probe is located in the lower right corner of the refrigerator.



*Secondary probe*

#### Fill Temperature Probe Bottle

##### Note

For each probe bottle, use approximately 4 oz. (120 mL) of product simulation solution (10:1 ratio of water to glycerin) (Packet included in refrigerator box).

1. Remove all probes from bottle and remove bottle from bracket.
2. Remove cap and fill with approximately 4 oz. (120 mL) of product simulation solution.
3. Secure cap on bottle and place in bracket.
4. Replace probes, immersing at least 2" (50 mm) in solution.

#### Install Additional Probe Through Top Port

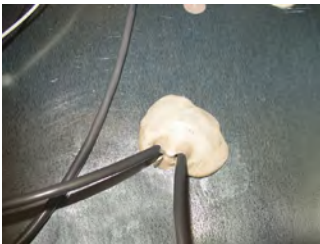

*Top access port*

1. Peel back putty to expose port.
2. Insert probe through port into chamber.
3. Insert probe into bottle.
4. Replace putty, ensuring a tight seal.



## 2.4 Chart Recorder (If Included)

### Note

For complete information, refer to the Temperature Chart Recorder Operation and Service Manual provided with this unit.



The chart recorder has a back-up battery system enabling a period of continuous operation if power is lost. Battery life varies by manufacturer as well as voltage level remaining. If full battery power is available, back-up power for the temperature chart recorder is available for up to 14 hours.

### Note

If chart recorder is operated on battery power, the battery should be replaced to ensure the back-up source has proper charge.

#### **Prior to use:**

Place probe in bottle with primary monitor probe.

#### **Set up and Operation**

Access chart recorder by pressing and releasing (i.Series) or pulling door open (Horizon Series).



*i.Series chart door*



*Horizon Series chart door*

### Install battery.

Connect the leads to the battery to provide back-up power to the chart recorder.

## Install / Replace Chart Paper

### Note

For accurate temperature reading, ensure the current time is aligned with the time line groove when the chart knob is fully tightened.



#### Chart recorder stylus and time line groove

1. Press and hold C button. When stylus begins to move left, release button. The LED flashes.
2. When stylus stops moving, remove chart knob then move knob up and away.
3. Place chart paper on chart recorder.
4. Gently lift stylus and rotate paper so current time line corresponds to time line groove.
5. Hold chart paper in place while making sure the chart knob is fully tightened. *(Failure to fully tighten the knob can result in paper slipping and losing time.)*
6. Press and hold C button. When stylus begins to move right, release button.
7. Confirm stylus is marking on paper and stops at the correct temperature.
8. Calibrate chart recorder to match primary temperature if needed and close recorder door.

#### Power Supply

The temperature chart recorder uses AC power when the system is operating. If AC power fails, the recorder continues to record temperature with back-up power provided by the nine-volt battery.

- ◆ The LED indicator glows green continually when main power is functioning and the battery is charged.
- ◆ The LED indicator glows red continually when main power is functioning and the battery is either not installed or needs to be changed.
- ◆ The LED indicator flashes red to indicate that the recorder is receiving power only from the back-up battery.
- ◆ The LED indicator flashes during chart paper change mode.

### 3 i.Series® Operation

#### 3.1 Initial Power-Up

1. Plug the power cord into a grounded outlet that meets the electrical requirements on the product specification label.
2. Turn the AC power switch ON.
3. Turn the Back-up battery switch ON.

**Note**

The Start screen is displayed when the i.C<sup>3</sup> is powered on. The i.C<sup>3</sup> will take approximately 2-5 minutes to boot up.



Start screen

The language screen is displayed when the i.C<sup>3</sup> is powered on. Use the Language screen to select the i.C<sup>3</sup> display language.

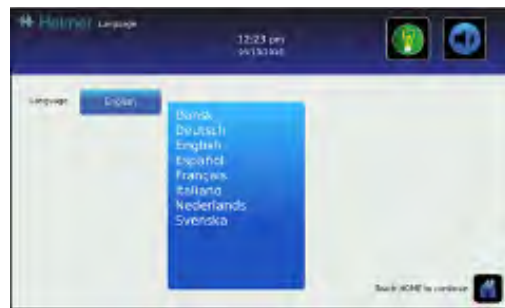

Language screens

**Note**

English is the default language.

If an alarm sounds, temporarily mute the alarm by touching the Mute button.



Home screen - alarm muted



Mute icon

**Note**

Active alarms are displayed on the Home screen. If an alarm condition other than High Temperature occurs, refer to the service manual for troubleshooting.

### 3.2 Operation

**i Notes**

- Refer to the i.C<sup>3</sup> User Guide for complete information regarding the i.C<sup>3</sup> User Interface.
- The i.C<sup>3</sup> Home screen displays temperature and alarm information, and provides icons to gain access to other functions of the i.C<sup>3</sup>.
- After two minutes of inactivity, the screensaver will be displayed. To return to the Home screen, touch the screensaver.



Home screen.

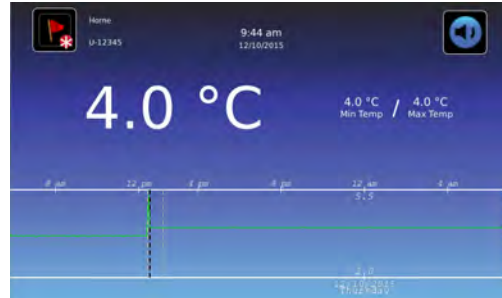

Home screensaver (touch to return to Home screen).

### 3.3 Change Temperature Setpoint

**i Note**

The Temperature Setpoint toggle button can be accessed from either the initial Settings screen or the Device Control Settings screen.



> Enter the Settings password. Select Temperature Setpoints. Touch minus (-) or plus (+) on spin box to change value.

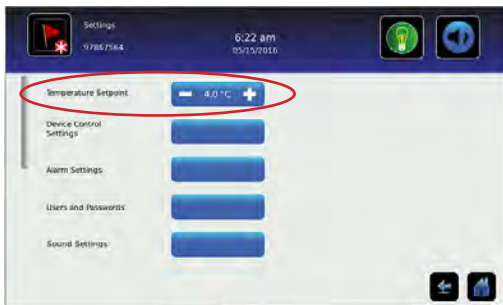

Settings screen

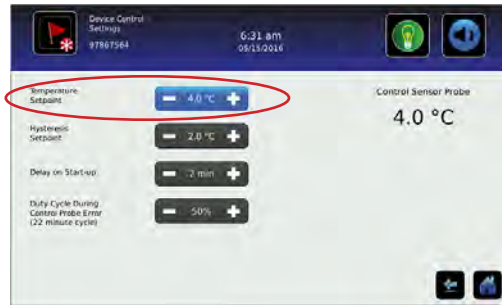



Device Control Settings screen

**i Notes**

- Default Settings password is 1234.
- Default setpoint is 4.0 °C.

### 3.4 Set Alarm Parameters

 >  > Enter the Settings password. Scroll down to select Alarm Settings. Touch minus (-) or plus (+) on spin box to set each alarm parameter.

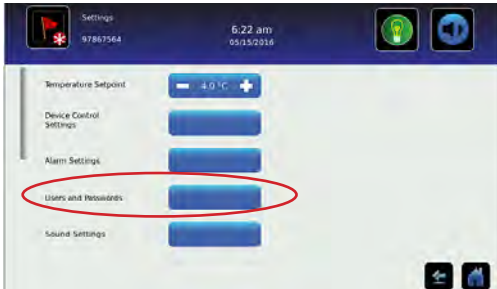

Settings screen



Alarms screens

Alarm settings control the conditions and timing of alarm condition indicators displayed on the i.C<sup>3</sup> Home screen.

### 3.5 Active Alarms



Home screen with active alarm

Table 1. i.Series Active Alarms

Alarm	Description
Primary Monitor Probe High Temp	Primary monitor probe reading is above high temperature alarm setpoint
Primary Monitor Probe Low Temp	Primary monitor probe temperature reading is below low temperature alarm setpoint
Primary Monitor Probe Failure	Primary monitor probe not functioning properly
Secondary Monitor Probe High Temp (if installed)	Secondary monitor probe reading is above high temperature alarm setpoint
Secondary Monitor Probe Low Temp (if installed)	Secondary monitor probe temperature reading is below low temperature alarm setpoint
Secondary Monitor Probe Failure (if installed)	Secondary monitor probe not functioning properly
Control Probe Failure	Control probe not functioning properly
Compressor High Temperature	Compressor temperature reading is above high temperature alarm setpoint
Compressor Probe Failure	Compressor probe not functioning properly
Power Failure	Power to unit has been disrupted
Door Open	Door is open beyond user-specified duration
Low Battery	Rechargeable battery voltage is low
No Battery	Battery is not connected
Communication Failure Messages 1, 2, 3	1 Communication lost between i.C <sup>3</sup> display board and control board 2 Communication lost between i.C <sup>3</sup> display board and internal system memory 3 Corrupt database

### 3.6 Mute and Disable Active Alarms

Audible alarms may be muted by touching the Mute icon to set delay. Touching the Mute icon repeatedly will increase the Mute delay timer incrementally between 5 - 60 minutes. The delay time remaining will be displayed in the bottom right corner of the icon. If the alarm is still active after the mute delay has ended, the audible alarm will sound.



Unmuted



Muted

### 3.7 Light Operation

Press Light Icon to turn LED lights ON or OFF.  
Auto ON/OFF feature can be configured in Settings.



Light ON/OFF

Table 2. Application Icons

Alarm	Description	Alarm	Description	Alarm	Description	Alarm	Description
	Home		Temperature Graph		Upload		Save
	Event Log		Alarm Test		Access Control		Cancel
	Mute		Information Logs		Access Log		Back Arrow
	Reset		Contact Information/ Contact Helmer		Defrost Cycle		Scroll
	Zoom Information		Display Brightness		Defrost Log		Temperature Graph Forward/Back
	i.C³ Applications		Icon Transfer		Alarm Conditions		Battery Power
	Settings		Download		Cancel Test		

\* = units with serial numbers prior to 2044369. Some exceptions may apply.  
Contact Helmer Technical Service at [techservice@helmerinc.com](mailto:techservice@helmerinc.com) for details.

## 4 Min/Max Temperature Monitoring

The Min/Max temperature display provides the highest and lowest Primary Monitor probe temperature reading since the last system reset (power-on event) or manually-initiated reset. Touch the Reset icon to the right of the display to manually reset.



### **i** Notes

- The Min/Max temperature display can be turned on or off through Display Settings.
- Once the time reaches the maximum display of 999 hours and 60 minutes, the message will display ">999:60", but minimum and maximum temperatures will continue to be tracked.



## 5 i.Lock™ Interlock Feature (Optional - Pharmacy models only)

The i.Lock™ Interlock feature is an electronically-activated magnetic lock which prohibits doors on opposite sides of the unit from being opened at the same time. This feature minimizes the risk of contaminating product or allowing airborne particulates to transfer from the uncontrolled side (ante-room or “dirty” room) to the clean room side of the unit.

### Notes

- The interlock feature does not restrict the use of both the left and right doors on the same side of a double door unit.
- During a power failure, the optional door interlock feature will continue to prevent opposite doors from being opened simultaneously until battery power is depleted or until the back-up battery switch is switched OFF.
- During a power failure, switch the battery back-up switch OFF and use the mechanical door key to provide secure storage for refrigerator contents.

## 6 Horizon Series™ Operation

### 6.1 Initial Power Up

1. Plug the power cord into a grounded outlet that meets the electrical requirements on the product specification label.
2. Turn the AC power switch ON.
3. Install 9 V back-up battery located on top of unit.
4. Press **Down Arrow** (Mute) if high temperature alarm sounds.



#### **Note**

If an alarm condition other than High Temperature occurs, refer to the service manual for troubleshooting.

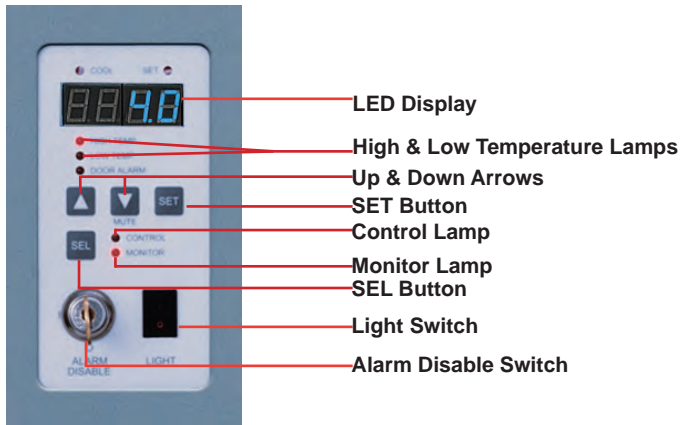

Monitor and Control Panel

### 6.2 Display Minimum and Maximum Monitor Temperature Recordings

#### **Notes**

- This feature is standard on Horizon Series™ models with serial numbers of 2015494 or higher. Some exceptions may exist. For confirmation on your unit, please contact Helmer Technical Service.
- This feature only applies to the Monitor temperature probe.
- Units which do not include the minimum and maximum recording feature will not display °C or °F when entering the program mode.

The minimum and maximum recording feature allows the user to view a minimum temperature occurrence and a maximum temperature occurrence within a given period of time. The timer provides a time reference in which those temperatures occurred.

#### **View minimum temperature recording**

1. Press and hold the **Down Arrow** button for one (1) second and listen for a single beep.
2. The display will alternate between **LO** and a valid temperature value five (5) times followed by a single beep to indicate exit back to the temperature display.



#### **View maximum temperature recording**

1. Press and hold the **Up Arrow** button for one (1) second and listen for a single beep.
2. The display will alternate between **HI** and a valid temperature value five (5) times followed by a single beep to indicate exit back to the temperature display.



### View recorded temperature timer

#### Notes

- The timer denotes the period of time that has elapsed. It does not display the time at which a minimum or maximum temperature occurred.
- The maximum period of time the timer can record is 99:59 (99 hours and 59 minutes).

1. Press and hold either the **Up** or **Down Arrow** button for 1 second.  or 
2. While the display is flashing the **HI** or **LO** value, press and hold the **SET** button for 1 second.
3. The display will alternate five (5) times between **CLr** and a value representing the number of hours and minutes that have elapsed since the last recording (example: 12:47 would represent 12 hours and 47 minutes). A single beep will follow to indicate exit back to temperature display.

### Clear minimum and maximum temperature recordings

1. Press and hold either the **Up** or **Down Arrow** button for 1 second.  or 
2. While the display is flashing the **HI** or **LO** value, press and hold the **SET** button for 1 second and listen for a single beep.
3. While the display is flashing the elapsed time since last reset, press and hold the **SET** button for 2 seconds. **CLr** will be displayed followed by a series of 3 beeps to indicate exit back to the temperature display.

#### Notes

The minimum and maximum temperature and timer will reset when:

- the unit is powered off and battery back-up is not engaged, or
- after 99 hours and 59 minutes have elapsed.

## 6.3 Change Temperature Setpoint

#### Note

Default setpoint is 4.0°C.

1. Press and release **SEL** to change to Control mode. The CONTROL lamp will illuminate.
2. Press and hold **SET** to display the current setpoint temperature.
3. Hold **SET** and press the **Up** or **Down Arrow** as necessary to set the desired setpoint value.
4. Release all buttons; the setpoint is changed.
5. Press and release **SEL** to return to Monitor mode. The MONITOR lamp will illuminate.

## 6.4 Set Parameter Values

1. Press and hold the **Up** and **Down Arrows** simultaneously for 3 seconds to enter program mode.
2. The LED Display will show .C or .F to indicate Celsius or Fahrenheit.
3. Press and release **SEL** button to scroll through the parameters.
4. Once the desired parameter is selected, press and hold the **SET** button while pressing the **Up** or **Down Arrow** to select the desired value.
5. Release **SET** button. The new setting is saved.
6. Press and hold the **Up** and **Down Arrows** simultaneously for 3 seconds to exit program mode.

### Note

Contact Helmer Technical Service to set Hysteresis values.

**Table 3. Parameter Values**

Parameter	Visual Indicator	Range	Default
Celsius or Fahrenheit	None	°C, °F	°C
High Temperature	MONITOR Lamp & HIGH Lamp	-40.0 to 25.0 (°C); -40 to 77 (°F)	5.5 °C
Low Temperature	MONITOR Lamp & LOW Lamp	-40.0 to 25.0 (°C); -40 to 77 (°F)	1.5 °C (HB); 2.0 °C (HPR)
Monitor Offset	MONITOR Lamp	-10.0 to 10.0 (°C); -18 to 18 (°F)	Varies
Control Offset	CONTROL Lamp	-10.0 to 10.0 (°C); -18 to 18 (°F)	Varies
Hysteresis	CONTROL Lamp	0.5 to 2.5 (°C); 1 to 5 (°F)	2.0 °C

## 6.5 Set Temperature Units

### Note

If temperature units are changed, the temperature setpoints, offsets and alarm settings must be recalibrated.

1. Press and hold the **Up** and **Down Arrows** simultaneously for 3 seconds to enter program mode.
2. The LED Display will show °C or °F to indicate Celsius or Fahrenheit.
3. Press and hold the **SET** button while pressing the **Up** or **Down Arrow** to select the desired temperature unit.
4. Release **SET** button. The new setting is saved.
5. Press and hold the **Up** and **Down Arrows** simultaneously for 3 seconds to exit program mode.

## 6.6 Temperature Calibration Offsets

Temperature calibration offsets indicate an acceptable margin of error between the actual temperature value and the desired temperature value.

### *Monitor Offset*

- ◆ Adjust if temperature displayed on the monitor does not correspond to the temperature reading of a calibrated reference thermometer in the same probe bottle.
- ◆ Value is factory-set to match a calibrated reference thermometer.
- ◆ Refer to the service manual for instructions regarding changing the Monitor Offset.

### *Control Sensor Offset and Hysteresis*

The control sensor affects the reading of the control probe temperature and therefore the actual temperature of the refrigerator. This should not be adjusted from the original setting unless directed by Helmer Technical Service.

Hysteresis helps control the refrigeration based on the control probe temperature reading and the set point and should not be changed from the default setting.

### NOTICE

Control Sensor Offset and Hysteresis are factory-preset and should not be changed. Contact Helmer Technical Service for instructions regarding changing these values.

## 6.7 Set Alarm Setpoints (Parameters)

1. Press and hold the **Up** and **Down Arrows** simultaneously for 3 seconds to enter program mode.
2. The LED Display will show °C or °F to indicate Celsius or Fahrenheit.
3. Press **SEL** until HIGH TEMP or LOW TEMP and MONITOR lamps flash.
4. Hold **SET**, then press **Up** or **Down Arrow** to change the setpoint.
5. Release **SET** button. The new setting is saved.
6. Press and hold **Up** and **Down Arrows** simultaneously for 3 seconds to exit program mode.

## 6.8 Active Alarms

The controller displays temperature and alarm information.

**Table 4. Horizon Series Active Alarms**

Alarm	Visual Indicator	Description
High Temperature	HIGH TEMP lamp flashes	Chamber temperature reading is above high temperature alarm setpoint
Low Temperature	LOW TEMP lamp flashes	Chamber temperature reading is below low temperature alarm setpoint
Power Failure	"PoFF" appears on display	Power to unit has been disrupted
Probe Failure	"Prob" appears on display	Probe not functioning properly
Door Open < 3 min.	DOOR ALARM lamp lights	Door is open (less than three minutes)
Door Open > 3 min.	DOOR ALARM lamp flashes	Door has been open 3 minutes or longer*

\*Audible alarm will sound after door is open for 3 minutes.

## 6.9 Mute and Disable Audible Alarms

### Note

Muting audible alarms does not disable alarm lamps or signals sent through the remote alarm interface.

- ◆ Press **Down Arrow** (Mute) to mute audible alarms.
- ◆ To disable all audible alarms, insert the key in the Alarm Disable switch and turn.

## 6.10 Light Operation

The light switch is located on the monitoring and control panel and controls the LED light within the chamber.

## 7 Product Specifications

### 7.1 Operating Standards

These units are designed to operate under the following environmental conditions:

- ◆ Indoor use only
- ◆ Altitude (maximum): 2000 m
- ◆ Ambient temperature range: 15 °C to 32 °C
- ◆ Relative humidity (maximum for ambient temperature): 80% for temperatures up to 31 °C, decreasing linearly to 50% at 40 °C
- ◆ Overvoltage category: II
- ◆ Pollution degree: 2
- ◆ Sound level is less than 70 dB(A).

**Table 5. Electrical Specifications (Blood Bank and Pharmacy)**

	225	456
<b>Input Voltage and Frequency</b>	115 V (60 Hz); 230 V (50 Hz); 230 V (60 Hz)	
<b>Voltage Tolerance</b>	±10%	
<b>Circuit Breakers</b>	6 A (230 V models, quantity 2)	7 A (230 V models, quantity 2)
<b>Current Draw</b>	9.25 A (115 V, 60 Hz) 5.1 A (230 V, 50 Hz) 5.8 A (230 V, 60 Hz)	13.25 A (115 V, 60 Hz) 7.8 A (230 V, 50 Hz) 8.2 A (230 V, 60 Hz)
<b>Power Source</b>	Grounded outlet, meeting national electric code (NEC) and local electrical requirements	
<b>Remote Alarm Capacity</b>	iB, iPR models: 0.5 A at 30 V (RMS); 1.0 A at 24 V (DC) HB, HPR models: 0.25 A at 30 V (RMS); 0.25 A at 60 V (DC)	

#### CAUTIONS

- The interface on the remote alarm monitoring system is intended for connection to the end user's central alarm system(s) that uses normally-open or normally-closed dry contacts.
- If an external power supply exceeding 33 V (RMS) or 60 V (DC) is connected to the remote alarm monitoring system's circuit, the remote alarm will not function properly; may be damaged; or may result in injury to the user.

**Table 6. Blood Bank Refrigerator Specifications**

Model	Voltage Code	Amps	Cu. Ft/ Liters	Cabinet	Door	Drawers	Dimensions W x H x D in. (mm)	Net Wt. lbs (kg)
							Exterior	
iB225	115V 60 Hz	9.25	26.5 (750)	Upright	Single hinged glass	6	29.5 x 80 x 40 (750 x 2032 x 1016)	579 (263)
	230V 50 Hz	5.1						
	230 V 60 Hz	5.8						
HB225	115V 60 Hz	9.25	26.5 (750)	Upright	Single hinged glass	6	29.5 x 80 x 40 (750 x 2032 x 1016)	568 (258)
	230V 50 Hz	5.1						
	230 V 60 Hz	5.8						
iB456	115V 60 Hz	13.25	58 (1642)	Upright	Double hinged glass	12	59.25 x 80 x 40 (1499 x 2032 x 1016)	852 (387)
	230V 50 Hz	7.8						
	230 V 60 Hz	8.2						
HB456	115V 60 Hz	13.25	58 (1642)	Upright	Double hinged glass	12	59.25 x 80 x 40 (1499 x 2032 x 1016)	841 (382)
	230V 50 Hz	7.8						
	230 V 60 Hz	8.2						

**Table 7. Pharmacy Refrigerator Specifications**

Model	Voltage Code	Amps	Cu. Ft/ Liters	Cabinet	Door	Shelves/ Drawers	Dimensions W x H x D in. (mm)	Net Wt. lbs (kg)
							Exterior	
iPR225	115V 60 Hz	9.25	26.5 (750)	Upright	Single hinged glass	3/3	24.25 x 70.5 x 28.25 (616 x 1791 x 718)	534 (243)
	230V 50 Hz	5.1						
	230 V 60 Hz	5.8						
HPR225	115V 60 Hz	9.25	26.5 (750)	Upright	Single hinged glass	3/3	24.25 x 70.5 x 28.25 (616 x 1791 x 718)	523 (238)
	230V 50 Hz	5.1						
	230 V 60 Hz	5.8						
iPR456	115V 60 Hz	13.25	58 (1642)	Upright	Double hinged glass	6/6	59.25 x 80 x 40 (1499 x 2032 x 1016)	797 (362)
	230V 50 Hz	7.8						
	230 V 60 Hz	8.2						
HPR456	115V 60 Hz	13.25	58 (1642)	Upright	Double hinged glass	6/6	59.25 x 80 x 40 (1499 x 2032 x 1016)	786 (357)
	230V 50 Hz	7.8						
	230 V 60 Hz	8.2						

 **Notes**

Maximum load per shelf or drawer - 100 lbs (46kg)

## 8 Compliance

### 8.1 Safety Compliance



This device complies with the requirements of directive 93/42/EEC concerning Medical Devices, as amended by 2007/47/EC.

This product is certified to applicable UL and CSA standards by a NRTL.



This device complies with FCC Radiated and Conducted Emissions Approval to CFR47, Part 15; Class A levels

### 8.2 Environmental Compliance



This device complies with the 2011/65/EU Directive for the Restriction of Hazardous Substances (RoHS).



This device falls under the scope of Directive 2102/19/EU Waste Electrical and Electronic Equipment (WEEE) .

When disposing of this product in countries affected by this directive:

- ◆ Do not dispose of this product as unsorted municipal waste.
- ◆ Collect this product separately.
- ◆ Use the collection and return systems available locally.

For more information on the return, recovery, or recycling of this product, contact your local distributor.

### 8.3 EMC Compliance

Helmer Scientific Refrigerators meet the applicable requirements of IEC61326 and EN55011 and are intended for use in the electromagnetic environment specified in 8.1 Operating Standards. The customer or the user of these devices should assure they are used in such environment.



Helmer Scientific  
14400 Bergen Blvd.  
Noblesville, Indiana 46060 USA



Emergo Europe  
Prinsessegracht 20  
2514 AP The Hague  
The Netherlands



## Appendix A

### i.Series Parts

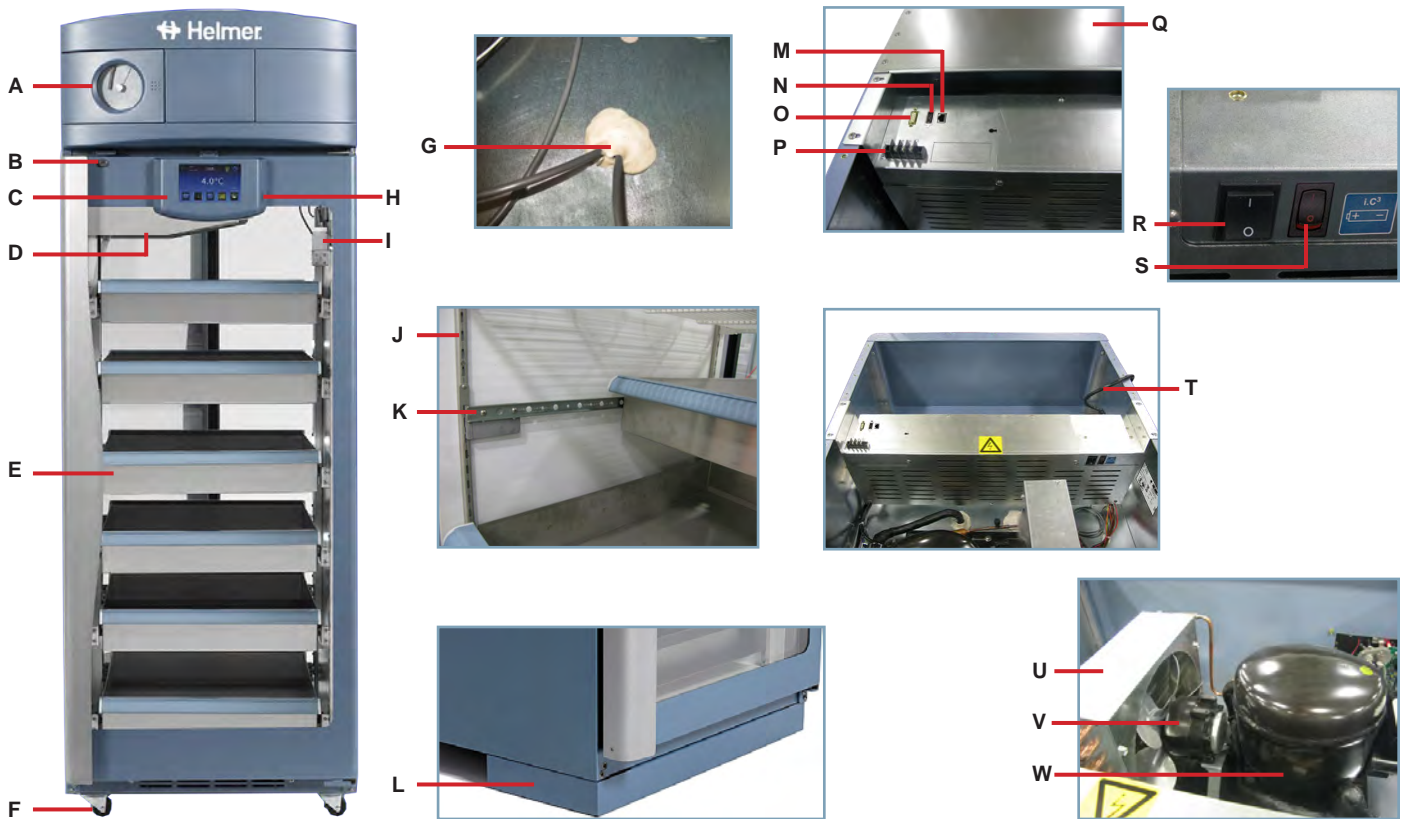

Table 9. i.Series Parts and Description

Letter	Description	Letter	Description
A	Chart recorder (standard on blood bank models / optional on pharmacy models)	M	USB port
B	Door lock	N	RJ-45 Ethernet port
C	i.C <sup>3</sup> control	O	RS-232 COM port (optional)
D	Unit cooler with fan guard	P	Remote alarm interface
E	Drawer (two-way)	Q	Cover (clean room side)
F	Caster	R	Main power switch
G	Access Port (number and location vary by model)	S	Back-up battery switch
H	USB	T	Power cord
I	Primary monitor probe bottle	U	Condenser
J	Standard for adjusting storage components	V	Condenser fan motor
K	Drawer/basket slide	W	Compressor
L	Skirt (optional, installed on the clean room, or non-control side)	Not shown	Monitoring system back-up battery
Not shown	Secondary probe bottle		

## Appendix B

### Horizon Series Parts

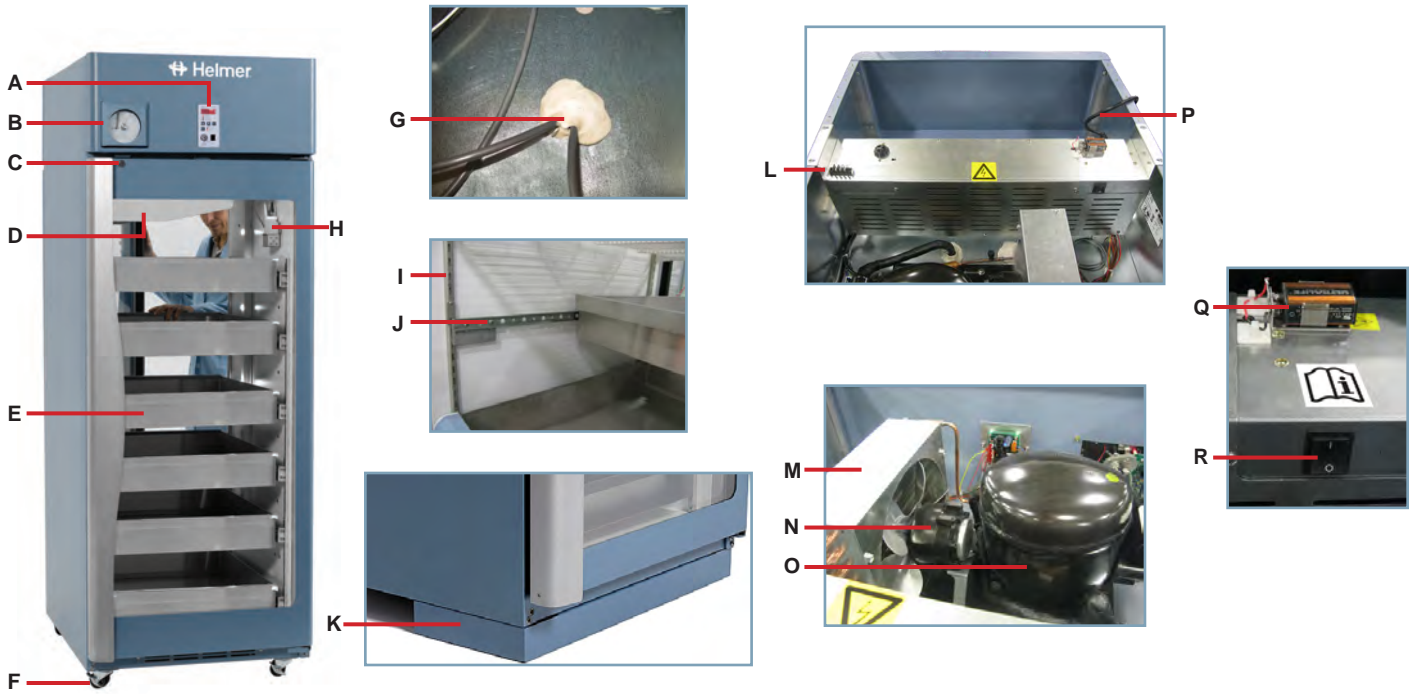

Table 10. Horizon Series Parts and Description

Letter	Description	Letter	Description
A	Horizon temperature monitor and control	K	Skirt (optional, installed on the clean room, or non-control side)
B	Chart recorder (standard on blood bank models / optional on pharmacy models)	L	Remote alarm interface
C	Door lock	M	Condenser
D	Unit cooler with fan guard	N	Condenser fan and motor
E	Drawer (two-way)	O	Compressor
F	Caster	P	Power cord
G	Access Port (number and location vary by model)	Q	Monitoring system back-up battery
H	Primary probe bottle	R	Main power switch
I	Standard for adjusting storage components	Not shown	Cover (clean room side)
J	Drawer/basket slide		

END OF MANUAL



