

Room air quality sensors

QPA10..
QPA20..

- Maintenance-free CO₂ sensing element (depending on type) based on optical infrared absorption measurement (NDIR¹)
- Or with VOC² sensing element based on a heated tin dioxide semiconductor
- CO₂ temperature (active or passive) and CO₂ humidity-temperature multisensor
- No recalibrations required
- Operating voltage AC 24 V or DC 15...35 V
- Signal outputs DC 0...10 V or DC 0...5 V adjustable
- Selectable passive temperature sensing element

1) NDIR = Non dispersive infrared

2) VOC = volatile organic compounds (also called mixed gas)

Use

In ventilation and air conditioning plants to enhance room comfort and optimize energy consumption by providing demand-controlled ventilation. The sensor acquires:

- CO₂ concentrations as an indication of occupancy in rooms where smoking is prohibited.
- VOC concentrations as an indication of odors such as tobacco smoke, body odor, or material fumes in the room.
- Relative humidity in the room.
- Room temperature.

Sensors QPA10... and QPA20... can be used as a:

- Control sensor.
- Transmitter for building automation and control systems and / or display units (QPA20...D only).

Typical use:

- Acquisition of CO₂ and VOC concentrations:
In party rooms, lounges, fair pavilions and exhibition halls, restaurants, canteens, shopping malls, athletic centers, sales rooms, and conference rooms.

- Acquisition of CO₂ concentrations:
In rooms with varying occupancy levels where smoking is prohibited, e.g. museums, theaters, movie theaters, auditoriums, office spaces, and school rooms.

Important!

QPA20... sensors may not be deployed as safety devices, e.g. as gas or smoke warning devices!

Type summary

Product number	CO ₂ measuring range	VOC time constant	Temperature measuring range	Humidity measuring range	Display of measured value
QPA1000	---	Slow (R1) Normal (R2) Fast (R3)	---	---	---
QPA2000	0...2000 ppm	---	---	---	No
QPA2002	0...2000 ppm	Slow (R1) Normal (R2) Fast (R3)	---	---	No
QPA2002D	0...2000 ppm	Slow (R1) Normal (R2) Fast (R3)	---	---	Yes
QPA2060	0...2000 ppm	---	0...50 °C / -35...+35 °C	---	No
QPA2060D	0...2000 ppm	---	0...50 °C / -35...+35 °C	---	Yes
QPA2062	0...2000 ppm	---	0...50 °C / -35...+35 °C	0...100 %	No
QPA2062D	0...2000 ppm	---	0...50 °C / -35...+35 °C	0...100 %	Yes
QPA2080	0...2000 ppm	---	Depending on connected sensing element	---	No
QPA2080D	0...2000 ppm	---	Depending on connected sensing element	---	Yes*

* The passive temperature measured value is not displayed

Ordering

When ordering, please give name and product number, e.g.:
Room air quality sensor **QPA2002**

Equipment combinations

All systems and devices capable of processing the following sensor signals:

- DC 0...10 V or DC 0...5 V or
- passive sensor signals for sensor QPA2080...

Mode of operation

CO₂ concentrations

Symaro™ air quality sensors acquire the CO₂ concentration by infrared absorption measurement (NDIR).

The resulting output signal DC 0...10 V or DC 0...5 V is proportionate to the CO₂ content of ambient air.

Function diagram CO₂
(output U1)

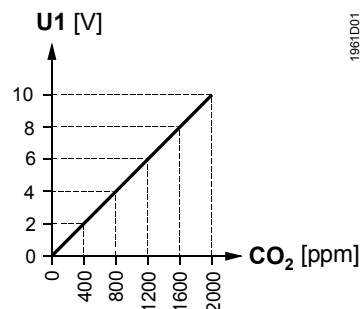

**VOC concentration
(QPA1000)**

Symaro™ air quality sensors determine the mixed gas concentration (VOC) using metal-oxide semiconductor sensing elements. The sensors measure precisely at all times and with no maintenance and recalibration required thanks to an integrated compensation mechanism, saving service costs. The sensor provides a DC 0...10 V or DC 0...5 V output signal proportionate to the VOC content of the ambient air.

Diagram VOC
(Output U1)

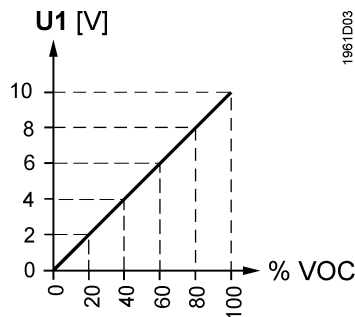

*Time constant
"VOC signal"*

Select the time constant for VOC measurement by limiting the maximum slew rate for the VOC signal. The jumper X4 (measuring range) fine tunes the time constant for VOC ventilation demand.

The center position (R2) produces a normal slew rate of max. 10% change to the VOC signal per minute (factory setting). The other 2 position reduce (R1, 2.5% VOC/min) or increase (R3, 40% VOC/min) the maximum slew rate. A smaller slew rate (R1) filters out short-term VOC concentration peaks, e.g. caused by a highly perfumed person passing by. The sensor reacts immediately and quickly to changes in VOC concentration at the higher slew rate (R3).

Time constant t_{63} selected by jumper X4 corresponds to <13 min (R1), <3.5 min (R2), or <1 min (R3) for a sudden change to 50% VOC.

**CO₂/VOC concentration
(QPA2002 and QPA2002D)**

The sensor acquires and evaluates the CO₂ / VOC concentration and transforms it to a ventilation demand signal.

It represents the result of maximum selection of the CO₂ measuring signal and the filtered VOC measuring signal. With maximum selection, the 2 demand signals are compared and provided as common air quality demand.

The ventilation demand signal is provided via output U2 as a DC 0...10 V or DC 0...5 V -signal to be supplied to the ventilation controller.

Ventilation demand
diagram (output U2)

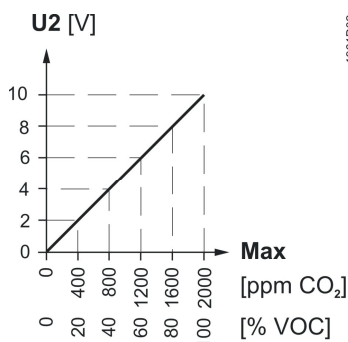

**Relative humidity
(QPA2062 and
QPA2062D)**

The sensor acquires the relative humidity in the room with a capacitive humidity sensing element whose capacitance changes as a function of relative humidity.

An electronic measuring circuit converts the signal from the sensing element to a continuous DC 0...10 V or DC 0...5 V signal, corresponding to a relative humidity range of 0...100 %.

**Temperature active
(QPA206...)**

The sensor acquires the room temperature with a sensing element whose electrical resistance changes as a function of the temperature.
The change is converted to an active DC 0...10 V or DC 0...5 V output signal
(\cong 0...50 °C or -35...+35 °C).

**Temperature passive
(QPA2080...)**

The sensor measures the room temperature using a sensing element where electrical resistance changes with the temperature of the ambient air.
The sensing element is on the device's rear side and connected at the appropriate connection terminals.
The following sensing elements are included with the device:
- LG-Ni1000
- Pt1000
- Pt100
- NTC 10kOhm

Sensing element

LG-Ni 1000:

Characteristic curve:

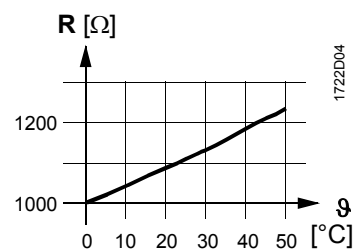

Accuracy:

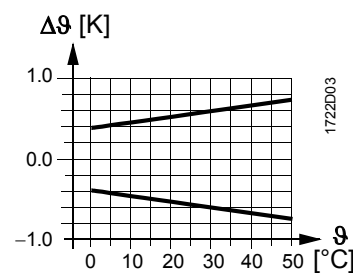

Pt 1000 (Kl. B)

Characteristic curve:

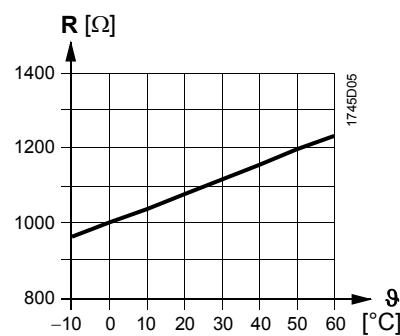

Accuracy:

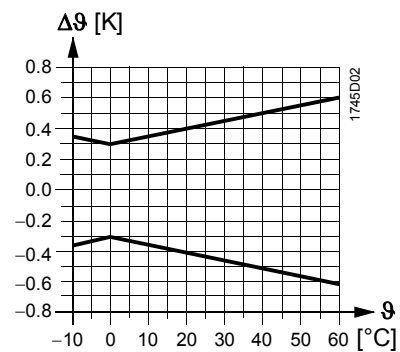

Pt 100 (Kl. B)

Characteristic curve:

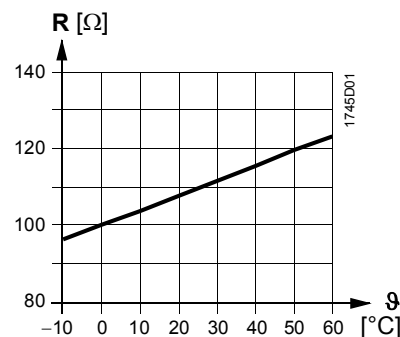

Accuracy:

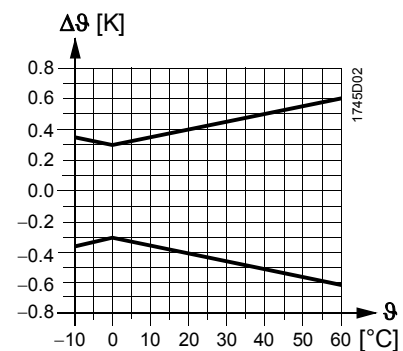

NTC 10k

Characteristic curve:

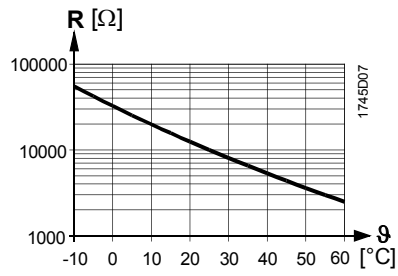

Accuracy:

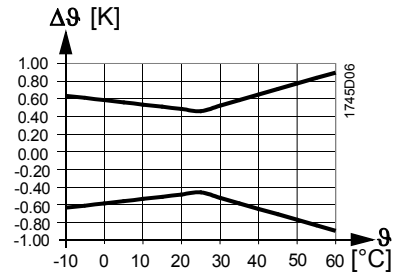

Key

R Resistance in Ohm
 θ Temperature in Celsius
 $\Delta\theta$ Temperature differential in Kelvin

Mechanical design

The units are designed for wall mounting and can be deployed with most types of commercially available recessed conduit boxes. The cables can be introduced from the rear (concealed wiring), from below or above (surface-run wires) through knockout openings.

The units consist of 2 major sections: Casing and base plate. Both snap together but can be detached again.

The measuring circuit, the sensing elements, and the setting elements are located on a printed circuit board in the unit.

The mounting base carries the connection terminals.

Setting elements...

QPA2000/2060/2060D
QPA2080/QPA2080D

Measuring range Output voltage		Test function active		
R1	R2	X4	U1	U2
Upper	Mid	Upper	10 V	5 V
Mid	Lower	Mid	0 V	5 V
Lower	Upper	Lower	5 V	10 V
Upper	Mid	Upper	5 V	0 V

Display Temperature unit
°F
°C

1961Z04en

QPA1000
QPA2002/QPA2002D
QPA2062/QPA2062D

Measuring range		* Test function active			
R1	R2	X4	U1	U2	U3
Upper	Mid	Upper	10 V	5 V	5 V
Mid	Lower	Mid	0 V	5 V	5 V
Lower	Upper	Lower	5 V	10 V	5 V
Upper	Mid	Upper	5 V	0 V	5 V

X17	U1	U2	U3
Upper	5 V	5 V	10 V
Mid	5 V	5 V	0 V
Lower	5 V	5 V	5 V
Upper	5 V	5 V	5 V

Output voltage
R4
R5
R6 X17

Display Temperature unit
°F
°C

* Set either X4 or X17 into test function, but not both at the same time.

The setting elements can be accessed after removing the mounting base.

... for the measuring range

Meaning of the different jumper positions:

with **QPA2000**

- For the CO₂ measuring range:
Jumper in the mid position (R2) = 0...2000 ppm (factory setting)

with **QPA1000, QPA2002 and QPA2002D**

- For VOC:
 - Jumper in the upper position (R1) = VOC time constant "slow"
 - Jumper in the mid position (R2) = VOC time constant "normal" (factory setting)
 - Jumper in the lower position (R3) = VOC time constant "fast"

with **QPA206...**

- For the temperature measuring range:
 - Jumper in the upper position (R1) = -35...+35 °C
 - Jumper in the mid position (R2) = 0...50 °C (factory setting)

...for output voltage for all QPA...	<ul style="list-style-type: none"> • <i>As per listing above R3 or R4 (depending on the device):</i> <ul style="list-style-type: none"> – Plugged in jumper = DC 0...10 V – Removed jumper = DC 0...5 V
... for the active test function	<p>Jumper for the measuring range in the vertical position: The signal output delivers the values according to table "Test function active".</p>
... for selection of the temperature unit on the display	<ul style="list-style-type: none"> • <i>For the unit of temperature:</i> <ul style="list-style-type: none"> – Jumper in the horizontal, lower position = °C (factory setting) – Jumper in the horizontal, upper position = °F
Behavior in the event of fault	
QPA1...	<ul style="list-style-type: none"> • In the event of VOC failure, DC 10 V or 5 V is present at signal output U1 (after 60 seconds).
QPA2...	<ul style="list-style-type: none"> • In the event of CO₂ failure, DC 10 V or 5 V is present at signal output U1 (after 60 seconds).
QPA2002	<ul style="list-style-type: none"> • In the event of CO₂ or VOC failure, DC 10 V or 5 V is present at signal output U2 (after 60 seconds).
QPA2060 and QPA2060D	<ul style="list-style-type: none"> • If the temperature sensor becomes faulty, 0 V is present at signal output U2.
QPA2062 and QPA2062D	<ul style="list-style-type: none"> • If the temperature sensor becomes faulty, 0 V is present at signal output U3, and the humidity signal at signal output U2 increases to DC 10 V or 5 V (after 60 seconds). • If the humidity sensor becomes faulty, DC 10 V or 5 V is present at signal output U2 (after 60 seconds), and the temperature signal remains active.
Display of measured values	<p>With sensors type QPA2002D, QPA2060D and QPA2062D, the measured values can be read on an LCD. The following measured values are displayed:</p> <ul style="list-style-type: none"> – CO₂ : In ppm – CO₂ + VOC: As a bar chart: 4 bars $\hat{=}$ U2 = 2 V, 20 bars $\hat{=}$ U2 = 10 V or 5 V) – Temperature: In °C or °F – Humidity: In % r.h. <p>The passive, measured temperature value cannot be displayed on type QPA2080D.</p>

Engineering notes

Room sensors with active outputs have a high power loss, which can influence temperature measurement.

The measuring accuracy is impacted by the following factors:

- Prevailing air flow
- Wall surface (rough, smooth)
- Wall texture (wood, plaster, concrete, brick)
- Wall type (interior, exterior).

This application-specific measuring inaccuracy is constant for an installed sensor after approx. 1 operating hour, and it can be adjusted as needed in a higher system (e.g. controller). No correction on the local LCD.

The sensor must be powered by a transformer for safety extra low-voltage (SELV) with separate windings, suited for 100 % duty. Size and fuse it in compliance with local safety regulations.

When sizing the transformer, consider the power consumption of the sensor. For information about wiring, see the data sheets of the devices with which the sensor is used. Observe maximum permissible cable lengths.

Cable routing and cable selection

When laying the cables, remember that electrical interference is greater the longer the cables run parallel and the smaller the distance between them. On applications with EMC problems, use shielded cables. For secondary power lines and signal lines, use twisted-pair cables.

Mounting notes

Mounting location	Inner wall of the room to be ventilated, not in niches, not behind curtains, not above or near heat sources, and not exposed to direct light from spot lights. Do not expose the sensor to direct solar radiation. Seal the end of the conduit at the sensor to prevent false measurements due to drafts through the conduit.
Mounting instructions	Mounting instructions are enclosed in the package.

Commissioning notes

The sensor's functions can be checked 30 minutes after applying power:

- Checking the CO₂ function:
In well ventilated rooms, the sensor shows the CO₂ concentration of the outside air. This is typically 360 ppm (the sensor's measuring accuracy must be considered). Also, a basic functional check can be made by exhaling on the sensor. In this case, remember that the sensor's rate of response is purposely delayed (time constant t_{63} = 5 min).
- Checking the VOC function:
Touch the sensor with a cotton ball dowsed in alcohol (e.g. gas from a cigarette lighter, without lighting a flame).

Ventilation should start when the preset switching level of the connected controller is reached.

After applying power to the types of sensor with display, Init appears for about 6 seconds.

Disposal



The devices are considered electronics devices for disposal in term of European Directive 2012/19/EU and may not be disposed of as domestic waste.

- Dispose of the device via the channels provided for this purpose.
- Comply with all local and currently applicable laws and regulations.

Technical data

Power supply	Operating voltage	AC 24 V \pm 20 % oder DC 15...35 V (SELV) oder AC/DC 24 V class 2 (US)
	Frequency	50/60 Hz at AC 24 V
	External supply line protection (EU)	Fuse slow max. 10 A or Circuit breaker max. 13 A Characteristic B, C, D according to or Power source with current limitation of max. 10 A
	Power consumption	QPA1000 < 0.8 VA QPA2000, QPA2060, QPA2060D, QPA2062, QPA2062D <1.7 VA, typ. <0.5 VA QPA 2080, QPA2080D QPA2002, QPA2002D <2.3 VA, typ. <1.0 VA
Cable lengths for measuring signal	Perm. cable lengths	See data sheet of the device handling the signal
Functional data "CO ₂ "	Measuring range	0...2000 ppm
	Measuring accuracy at 23 °C and 1013 hPa	$\leq \pm(50 \text{ ppm} + 2 \% \text{ of measured value})$
	Temperature dependency in the range of -5...45 °C	$\pm 2 \text{ ppm} / ^\circ\text{C}$ (typically)
	Long-time drift	$\leq \pm 5\%$ of measuring range / 5 years (typically)
	Time constant t_{63}	< 5 min
	Output signal, linear (terminal U1)	DC 0...10 V or DC 0...5 V $\hat{=}$ 0...2000 ppm, max. $\pm 1 \text{ mA}$
	Recalibration-free	8 years

Functional data "VOC"	Measuring range	0...100% VOC
	Time constant t_{63} VOC (CO ₂ see above)	<13 min (R1), <3.5 min (R2), <1 min (R3)
	Output signal, linear (terminal U1)	DC 0...10 V or DC 0...5 V $\hat{=}$ 0...100%, max. \pm 1 mA
Functional data "Maximum selection from CO ₂ and VOC" for QPA2002 and QPA2002D	Output signal, linear (terminal U2)	DC 0...10 V or DC 0...5 V $\hat{=}$ max. of 0...2000 ppm, CO ₂ or 0...100% VOC, max. \pm 1 mA
	Range of use	0...95 % r.h. (non-condensing)
Functional data "Rel. Humidity" for QPA2062 and QPA2062D	Measuring range	0...100 % r.h.
	Measuring accuracy at 23 °C and AC 24 V	
	0...95 % r.h.	\pm 5 % r.h.
	30...70 % r.h.	\pm 3 % r.h. (typically)
	Temperature dependency	\leq 0.1 % r.h./°C
	Time constant	approx. 20 s
	Output signal, linear (terminal U2)	DC 0...10 V or DC 0...5 V $\hat{=}$ 0...100 % r.h., max. \pm 1 mA
Functional data "Temperature" with QPA206...	Measuring range	0...50 °C (R2, R3) or -35...+35 °C (R1)
	Measuring accuracy at AC 24 V in the range of	
	23 °C	\pm 0.3 K
	15...35 °C	\pm 0.8 K
-35...+50 °C	\pm 1 K	
Functional data "Temperature" with QPA208...	Time constant t_{63}	8.5 min
	Sensing range	see "Mode of operation"
	Measuring accuracy	see "Mode of operation"
	Time constant t_{63}	8.5 min
	Correction Intrinsic heat	1.4 K (typically)
	Output signal (terminal B, M)	passive
Display of measured value	With QPA2002D, QPA2060D, QPA2062D, QPA2080D	LCD
	Degree of protection	Protection degree of housing IP30 according to EN 60529
Electrical connections	Protection class	III according to EN 60730-1
	Screw terminals for	1 \times 2.5 mm ² or 2 \times 1.5 mm ²
Environmental conditions	Operation to	IEC 60721-3-3
	Climatic conditions	Class 3K3
	Temperature (housing incl. electronics)	0...50 °C
	Humidity	0...95 % r.h. (non-condensing)
	Mechanical conditions	class 3M2
	Transport to	IEC 60721-3-2
Climatic conditions	Class 2K3	
Temperature	-25...+70 °C	
Humidity	<95 % r.h.	
Mechanical conditions	Class 2M2	
Materials and colors	Cover	ASA + PC, NCS S 0502-G (white) equates to RAL9010
	Housing	ASA + PC, NCS 2801-Y43R (grey) equates to RAL7035
	Mounting plate	PC, NCS 2801-Y43R (grey) equates to RAL7035
	Sensor (complete)	Silicone-free
	Packaging	Corrugated cardboard
Directives and Standards	Product standard	EN 60730-1
	Electromagnetic compatibility (Applications)	Automatic electrical controls for household and similar use
	Electromagnetic compatibility (Applications)	For use in residential, commerce, light-industrial and industrial environments
	EU Conformity (CE)	CE1T1961xx ^{*)}
	RCM Conformity	CE1T1961en_C1 ^{*)}
UL	UL 873, http://ul.com/database	
Environmental compatibility	The product environmental declaration CE1E1961 ^{*)} contains data on environmentally compatible product design and assessments (RoHS compliance, materials composition, packaging, environmental benefit, disposal).	
Weight	Incl. packaging	
	Without display	approx. 0.10 kg
	With display	approx. 0.12 kg

ppm = parts per million (number of parts per one million parts)

*) The documents can be downloaded from <http://siemens.com/bt/download>.

Connection terminals

QPA1000

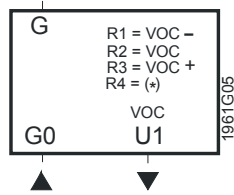

QPA2000

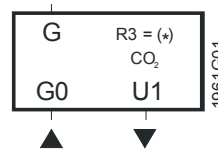

QPA2002, QPA2002D

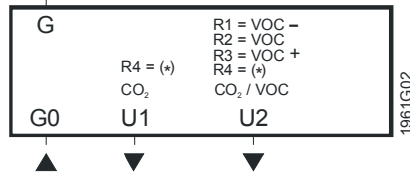

QPA2060, QPA2060D

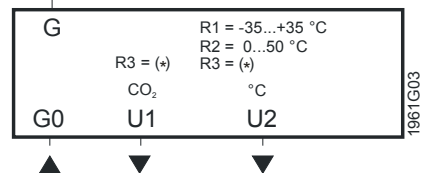

QPA2062, QPA2062D

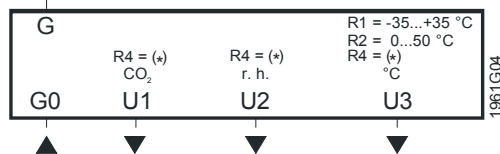

QPA2080, QPA2080D

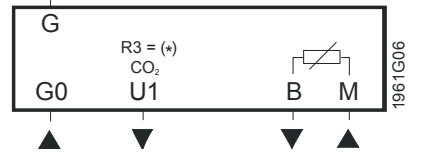

- G System potential AC 24 V (SELV) or DC 15...35 V
- G0 System neutral and measuring neutral
- U1 Signal output DC 0...10 V or DC 0...5 V
- U2 Signal output DC 0...10 V or DC 0...5 V
- U3 Signal output DC 0...10 V or DC 0...5 V
- R...(*) Signal output with R... = DC 0...10 V
Signal output without R... = DC 0...5 V
- B, M Passive temperature output (interchangeable)

Dimensions

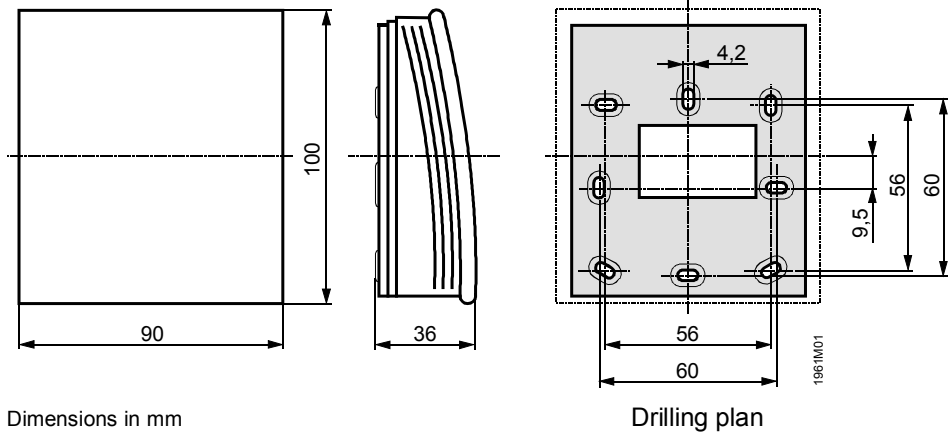

Issued by
Siemens Switzerland Ltd
Building Technologies Division
International Headquarters
Gubelstrasse 22
6301 Zug
Switzerland
Tel. +41 58-724 24 24
www.siemens.com/buildingtechnologies

© Siemens Switzerland Ltd, 2005
Technical specifications and availability subject to change without notice.